

NOMAD PRO™

*Handheld X-ray System for
Intraoral Radiographic Imaging*



OPERATOR MANUAL

MANUFACTURED BY **ARIBEX**™

DO NOT OPERATE THIS DEVICE UNTIL YOU HAVE READ THIS MANUAL and reviewed the accompanying materials.

Disclaimer: NOMAD® Pro is sold with the understanding that the user assumes sole responsibility for radiation safety (as well as any state, provincial, or local regulatory compliance) and that Aribex, Inc., its agents or representatives, do not accept responsibility for:

- a) injury or danger to personnel from X-ray exposure,
- b) image over/under exposure due to poor operating techniques or procedures,
- c) equipment not properly serviced or maintained in accordance with instructions contained in this publication, and
- d) equipment which has been damaged, modified, or tampered with in any way.

Aribex and **NOMAD** are registered trademarks within the United States and other countries. **NOMAD Dental**, **NOMAD Pro**, **PORTA-X**, and the **ARIBEX** and **NOMAD** logos are trademarks of Aribex, Inc. worldwide. U.S. patents issued: 7,224,769 and 7,496,178. United States and international patents pending. All other brand and product names are trademarks or registered trademarks of their respective companies.

The symbols used in this publication or used to mark the equipment have the following meanings:













	Attention, consult accompanying documents
 	Ionizing Radiation
	Type BF Equipment (providing a degree of protection against electric shock, pertaining particularly to allowable leakage currents)
 	Instructions for handling product at end of life
	Reference to a radiation filter or a value of filtration
	Manufacturer of the device
	Date of device manufacture
	Model number or corresponding name
	Power supply positive/negative orientation
	Unique serial number for the device
	Dangerous Voltage



Table of Contents

1.0 Getting Started	1
1.1 Intended Use	1
1.2 Unpack, Check, and Register NOMAD Pro System	1
1.3 Charging the Handsets	2
2.0 Safety Precautions	3
2.1 Radiation Safety	3
2.2 Usage and Duty Cycle	5
2.3 Cleaning	6
2.4 Security, Storage, and Transportation	6
3.0 Setup and Power Check	7
3.1 The Backscatter Shield.....	7
3.2 Attaching a Charged Handset.....	8
3.3 Checking for Power	8
3.4 Optional Checks	9
4.0 Operation	10
4.1 Power On.....	10
4.2 Ensuring Battery Charge Is Adequate	10
4.3 Lock / Unlock the X-ray.....	10
4.4 Ensuring the Right Exposure Time Is Set	11
4.5 Ready the Device	11
4.6 Initiating and Completing an X-ray Exposure.....	12
4.7 Power Off.....	12
4.8 Exposure Techniques	13
4.9 Settings Menu.....	14
4.10 Technique Factor Settings and Adjustments	16
5.0 Handset Replacement and Care	17
6.0 NOMAD Pro Care and Upkeep	18
6.1 Alarms and Alerts	18
6.2 Troubleshooting.....	21
6.3 Repair and Maintenance.....	23
7.0 Technical Description	24
7.1 Basic Technical Specifications.....	24
7.2 Wiring Diagram	25
7.3 X-ray Tube Specifications and Characteristics	26
7.4 EMC Data.....	29
7.5 Optional Calibration Checks	31

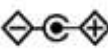
Thank you for choosing the Aribex® NOMAD Pro as your X-ray solution!

At Aribex we value your business and we would like to hear from you, because your feedback or suggestions are important to us. If you have comments, please email us: NOMAD@aribex.com

NOMAD® Pro Dental Features:

- **Performance** – battery power source delivers dependable high voltage (60kV, true DC) and direct current (2.5mA).
- **Consistent Emission Radiation** – high-frequency, constant-potential X-ray generator provides high quality images, with a lower radiation dosage to the patient than standard AC X-ray systems.
- **Radiation Protection** – operator shielded from source and backscatter radiation.
- **Simple Operation** – by selecting patient size, receptor type and tooth type the factory preset exposure time is digitally displayed on the user-friendly control panel along with indicators for machine and battery status.
- **Lightweight and Ergonomic** – design provides complete flexibility and convenience, enabling exposures without moving the patients to the X-ray source.
- **Exposure Safety Feature** – cannot emit X-rays with insufficient voltage (low battery).
- **Engineered for Compatibility** – works with both film and digital imaging systems.
- **Authorized Service** – complete support and maintenance from Aribex and through our authorized distributors.
- **X-ray Locking Feature** – enables the safe training, demonstration, and storage of the device without undue concern related to unintended or unauthorized radiation emission.

1.0 Getting Started

1.1 Intended Use

The NOMAD Pro X-ray System is designed to be used for both adult and pediatric patients by trained dentists and dental professionals for producing diagnostic dental X-ray images.

1.2 Unpack, Check, and Register NOMAD Pro System

1 Unwrap individual components from the protective plastic and check for any noticeable signs of damage. The standard package system includes the following items:



- NOMAD Pro Device (AP-0015)
- 2 Handsets (AP-0025)
- Charging Cradle (AP-0035) and the AC/DC Power Supply (CP-0062)
- Certificate of Conformance, Getting Started guide (MP-0075), Warranty / Registration Card, and NOMAD Pro Operator Training CD (MP-0073)

2 Preliminary Checks:

Item	Check
Device Labels	Verify that the serialized Device label is in place (located on lower side of unit).
Other Labels	Verify that the serial number on the Warranty/Registration card matches the device serial number and the device serial number on the carrying case. Verify that the Handsets label (located on the top of each Handset) and the Charging Cradle label (located on the bottom of the Charging Cradle) are all in place.
Collimator Cone and Backscatter Shield	These two items provide operator protection and should be inspected for shipping damage.
Trigger Switch	Should freely move in and out when depressed and released.
Device Housing	Should be free of cracks or fractures.

3 Complete the product Warranty / Registration card and mail it with proper postage to Aribex today. Completing the card fulfills a condition of warranty coverage (see the inside back cover of this manual).

1.3 Charging the Handsets

NOTE: The handsets (batteries) are partially charged at the factory and normally need not be charged up prior to initial use of the NOMAD Pro. However, if the system has been in long-term storage prior to initial use, handsets will first require a proper charge. In fact, it is recommended to fully recharge handsets every 3 months for long-term storage to ensure that no low battery becomes damaged.

① Use only the supplied AC/DC Power Supply (CP-0062), unwrap the power cord of the power supply and connect it to the charging cradle then to an AC electrical outlet (110/120V or 220/240V, dictated by the country/region). The single green indicator light on the top of the charging cradle will illuminate when the cradle has power. Position the charging cradle away from the normal patient environment. A plug adapter may be needed to accommodate the local AC configuration.



② Invert one of the handsets and carefully slide it onto the charging cradle (do not force the handset onto the charging cradle or damage may result). Expect charge time to be less than 3 hours. The handset, charging cradle, and AC power supply may become warm to the touch while charging. The handset may be left on the charging cradle overnight without damaging the batteries.

③ While the batteries are charging, the bank of LED charge indicators will illuminate green in a pulsed pattern. Once charging is complete, the bank of indicators will illuminate solid green. The handset may be left on the charging cradle without damage to the batteries.

④ If the charge indicator lights change to red, it is an indication of problems; consult Section 6.2, *Troubleshooting* or an Aribex authorized service center.

2.0 Safety Precautions

2.1 Radiation Safety



This X-ray unit may be dangerous to patient and operator unless safe exposure factors, operating instructions and maintenance schedules are observed.



- ❖ Operators must follow all applicable regulatory guidelines and in-house radiation protection program in regard to patients and operators who are pregnant or expect to become pregnant.
- ❖ Operators must be fully acquainted with industry safety recommendations and established maximum permissible doses.
- ❖ Optimal operator radiation backscatter protection exists when:
 - a) the backscatter shield is positioned at the outer end of the collimator cone,
 - b) the backscatter shield is close to the patient,
 - c) the patient tilts their head when needed to accommodate exposures (see Section 4.7), and
 - d) the operator remains within the significant zone of occupancy immediately behind the device shield.
- ❖ Do not enable NOMAD Pro until patient and operator are positioned and ready for the exposure, preventing interruption and inadvertent exposure of anyone to X-rays.
- ❖ Do not attempt an exposure if anyone other than patient is in the direct beam. If others are assisting, then they should wear protective covering.
- ❖ When selecting and using Position Indicating Devices (PIDs), preference should be given to models that allow the backscatter shield to remain at the outer end of the collimator cone for maximum operator protection.

NOMAD Pro

☢ An exposure can be terminated for any reason by abruptly releasing the depressed trigger (for more information, see Section 4.0, *Operation*).

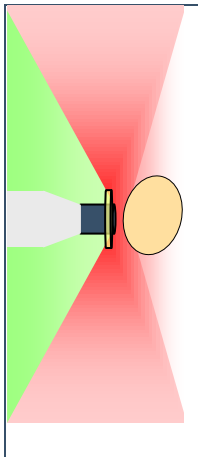

Proper positioning
MAXIMUM PROTECTION

☢ As shown in graphic representations, maximum protection (green area) from backscatter radiation (red area) exists when the NOMAD Pro is positioned near the patient, is perpendicular to the operator (with the patient's head tilted if needed), and the backscatter shield is fully extended toward the patient and parallel to the operator.

☢ Operation outside the protection zone (or with a diminished protective zone) requires proper precautions such as the use of lead aprons.

☢ **Do not operate if the backscatter shield or collimator cone are broken!**

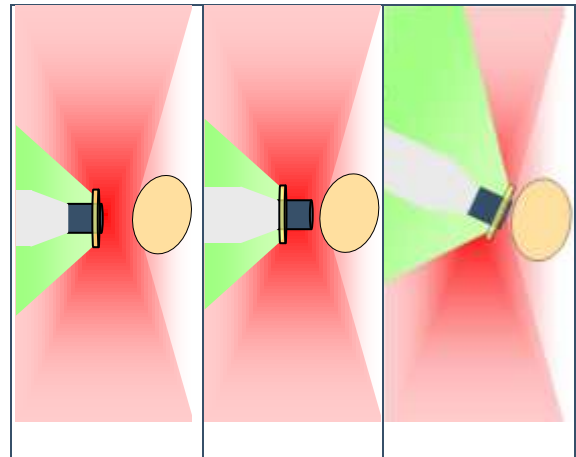

Device held back Shield slid back Non-perpendicular
MINIMIZED PROTECTION

Comparative Data for Whole Body Exposure (Annual)

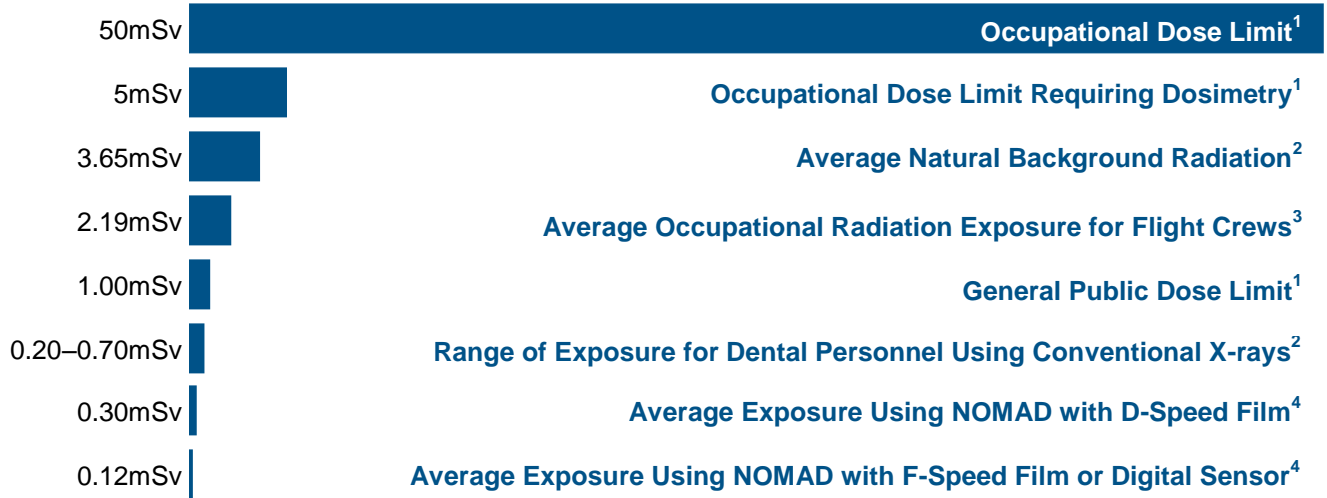

1) Standards for Protection Against Radiation, 10 CFR 20 (US Federal Standards), 1994 (see also *NCRP Report No. 116*)
 2) *NCRP Report No. 145* (National Council on Radiation Protection and Measurements), p7-9
 3) "Estimated Cosmic Radiation Doses for Flight Personnel", Feng YJ et al, *Space Medicine and Medical Engineering*, 15(4) 2002, p265-9
 4) Normalized average assumes 7,200 exposures per year, and the average length of exposure for D-speed = 0.50 seconds, F-speed = 0.25 seconds, digital sensor = 0.20 seconds

Comparative Data for Hand and Extremity Exposure (Annual)

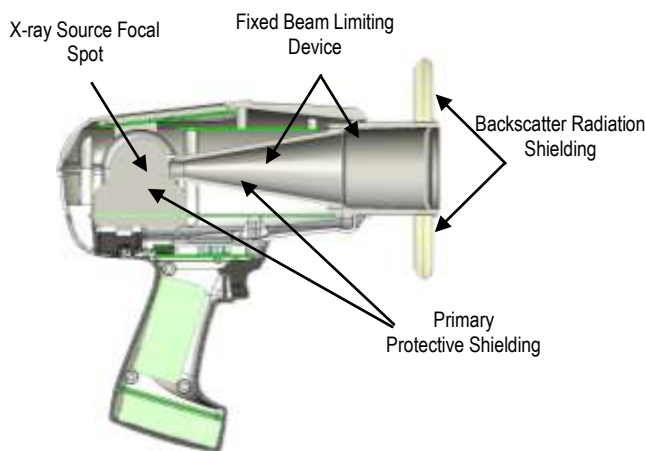
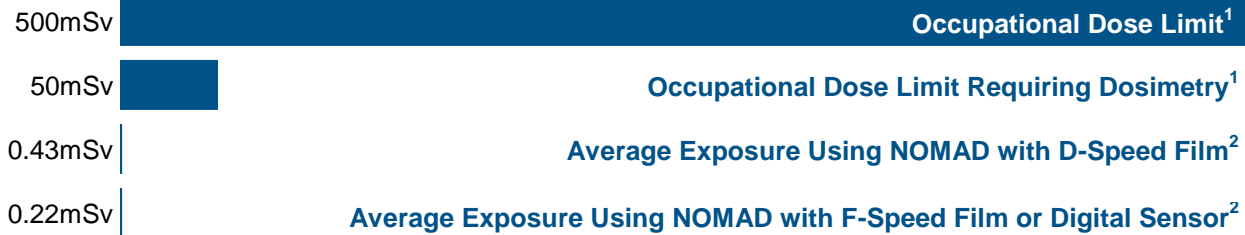

1) Standards for Protection against Radiation, 10 CFR 20 (US Federal Standards), 1994 (see also *NCRP Report No. 116*)

2) "Radiation Exposure with the NOMAD Portable X-ray System", Goren AD et al, *Dentomaxillofacial Radiology*, 37 (2008), p109-12; normalized average (includes leakage and backscatter radiation) assumes 7,200 exposures per year, and the average length of exposure for D-speed = 0.50 seconds, F-speed = 0.25 seconds, digital sensor = 0.20 seconds



In implementing a radiation protection program, consult all applicable regulations governing radiation protection and the use of X-ray equipment, and ensure full compliance with any such regulations.

2.2 Usage and Duty Cycle

As a safety feature, NOMAD Pro will not emit X-rays with insufficient voltage (low battery).

The NOMAD Pro is also designed to avoid damage from overheating. The minimum duty cycle rating for maximum exposure (the relationship between duration and frequency of exposures taken during a rolling 60 second period) is 1:60. This duty cycle is programmed into your NOMAD Pro. Examples of optimal use:

Exposure Duration	0.09 sec	0.20 sec	0.40 sec	1.00 sec
Hypothetical Time Between Exposures	6 seconds	12 seconds	24 seconds	60 seconds
Exposures Per Minute	>10	>8	>2	1

NOMAD Pro



Do not operate NOMAD Pro, the handset, charging cradle, or AC power supply if equipment was subjected to moisture (wetting, immersing, or soaking) – return to Aribex for service.



- Do not open the housings. Doing so will void the warranty. There are no user serviceable parts inside the NOMAD Pro, handset, charging cradle or AC power supply.
- NOMAD Pro should not be used in environments where flammable cleaning agents are present.
- Locate the charging cradle away from the normal patient environment.

2.3 Cleaning

- 1 Routinely use a **non-acetone** based disinfectant wipe (according to chemical manufacturer's recommendations) to disinfect the exterior surfaces of the NOMAD Pro and the handset in between use on each patient.
- 2 Leave the handset connected to the NOMAD Pro and wipe down all surfaces of the device.
- 3 Unplug the charging cradle before cleaning.

NOTE: NOMAD Pro, the handsets, the charging cradle, and the AC power supply are not designed to be subjected to any kind of sterilization procedure.



Do not spray disinfectant or cleaners directly on the NOMAD Pro, handsets, charging cradle or AC power supply. The connecting areas are open to ingress and damage to your device may result.

2.4 Security, Storage, and Transportation

- Do not store the NOMAD Pro, handsets, charging cradle, or AC power supply in extreme conditions: below -20°C (-4°F) or above $+60^{\circ}\text{C}$ ($+140^{\circ}\text{F}$), or beyond 95% relative humidity (non-condensing). The optimal storage location is cool, dry, and away from direct sunlight.
- Aribex recommends that the NOMAD Pro (like all electronic equipment) be allowed to acclimate before use when switching between temperature extremes (i.e, cold storage to a warm area use or hot area storage to a cool area use).
- When finished for the day with NOMAD Pro, detach the handset.

- The **X-RAY LOCK** and **UNLOCK** (Section 4.3) serves as the device security key to prevent unauthorized use. In addition, it is recommended that the device be locked away when not in use. For a further level of security, securely store handsets in a separate location.
- Take steps to ensure the NOMAD Pro will not be knocked to the ground when not in use. Lay it on its top, side or in the accessory cradle. Power will automatically shut off after a period of inactivity (approximately 3 minutes).
- Do not store or carry handsets so that metal objects can contact exposed battery contact springs.
- Some battery charge may be lost during extended inactivity (leading to fewer exposures between handset charging).



- **NOMAD Pro should not be operated if it has been dropped or performance degrades; it should be returned to Aribex for a safety check.**
- **When finished for the day with NOMAD Pro, detach the handset.**
- **For long-term storage, it is recommended to fully recharge handsets every 3 months.**

3.0 Setup and Power Check

3.1 The Backscatter Shield

In addition to the radiation shielded cone, the backscatter shield provides additional protection to the operator, and features an adjustable position to permit exposures made at various angles.



- 1 Ideally, the shield should remain fully extended to the outer edge of the cone, as close to the patient as possible during each image taken (see 2.1, *Radiation Safety*).
- 2 You may find that the backscatter shield needs to be adjusted to accommodate position indicating devices or angled exposures. If adjustments are needed, gently glide the shield up or down along the cone using equal pressure to maintain a perpendicular alignment and avoid binding.
- 3 To keep the shield securely on the cone a cap is permanently attached at the outer cone end. Do not attempt to remove this cap or to remove the backscatter shield. Attempting to do so will result in damage to your device.

NOMAD Pro

3.2 Attaching a Charged Handset

1 With the NOMAD Pro placed bottom up on a secure surface, properly orient and carefully slide the charged handsets onto the base of the NOMAD Pro, (a properly oriented handset should click into place with firm pressure).

2 The clicking sound ensures the locking mechanism has secured the NOMAD Pro to the handset. To verify this lock apply slight pressure in the release direction.



There are electric currents present at the handset terminals. Protect the handset from damage; do not probe with fingers or conductive objects.

3.3 Checking for Power

NOMAD Pro Control Panel

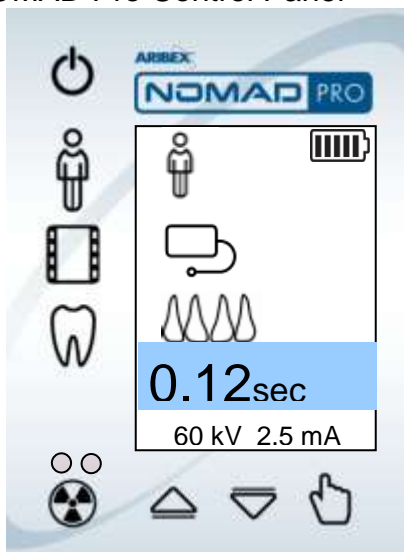

- 1 After locking a handset in place press the **Power** (⏻) button.
- 2 The operation control display panel will activate with a "battery power level" icon in the upper right corner. Five bars is an indication of a fully charged handset.
- 3 If the battery charge is too low, the NOMAD Pro will not emit an X-ray and the **RECHARGE BATTERY** alarm will display. (The **RECHARGE BATTERY** alarm may also display if the handset is not fully engaged.)
- 4 When a battery is depleted to the single bar level (▢), Aribex recommends the handset be recharged.

5 Replace a low charge handset with the secondary handset (which should be charged in advance).

3.4 Optional Checks

The NOMAD Pro is factory calibrated and tested prior to release (see your *Certificate of Conformance*). Each time the device power is turned on, it automatically runs a self diagnostic to ensure proper function. However, the optional checks listed below may be performed periodically as desired.



NOMAD Pro has an X-ray disable feature that allows the X-rays to be disabled for training purposes. Test firing this X-ray unit may otherwise be dangerous to the testing technician or bystanders. See Section 4.3 for more information.

Power On/Off: Attach a fully charged handset to the NOMAD Pro device. Press the **Power** (⏻) button and verify the Power On and Power Off states.

Increase/Decrease Exposure Time: With the device on, select the patient size, the image receptor type, and the tooth type. The exposure time corresponding to the selections will display on-screen. Press **Increase** (⬆) and the **Decrease** (⬇) buttons, and verify that the exposure time changes appropriately.

Triggering: With the device on and an exposure time selected, press and release the trigger once – this will ready the device, and the display will indicate the X-ray **READY** state. Press any push button on the user interface panel or wait approximately 15 seconds for the timeout – the X-ray **READY** state will end.

Automatic Shutdown: With the device on, allow approximately 3 minutes of inactivity to pass for the system to automatically turn off or shut down.

X-ray Disable: With the device on, press and hold down the **Select** (👉) button and in combination then press the **Patient** (👤) button – the device shifts into a **X-RAYS LOCKED** state and the buttons can be released. Repeat the process to unlock the X-ray.



NOMAD Pro should not be operated if it has been dropped or performance degrades; it should be returned to Aribex for a safety check.

See Section 6.1, *Alarms and Alerts* for more information.

4.0 Operation

4.1 Power On



Press and release **Power** (⏻) button to turn on NOMAD Pro. An audible double tone and an active display panel indicate the device has power. Settings are redisplayed according to what was last displayed or saved when the device was turned off (unless the device was disconnected from a charged handset for more than 1 minute).

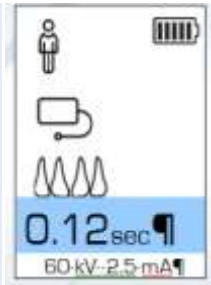

4.2 Ensuring Battery Charge Is Adequate



At the completion of each day or when the battery indicator reaches one bar, recharge the handset. (Aribex recommends that you keep one handset fully charged at all times to ensure continuous operation.)

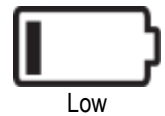

4.3 Lock / Unlock the X-ray



The X-ray lock and unlock functionality can be toggled to prevent unauthorized use when the NOMAD Pro is idle or stored.

LOCK / UNLOCK is activated by pressing and holding down the **Select** (👉) button and then pressing the **Patient** (👤) button – the device shifts into a **X-RAYS LOCKED** state and the buttons can be released. Repeat the process to "unlock" X-rays.

For security and training purposes, the operator may easily toggle between these setting as needed by repeating the key selection.

NOTE: If the **Select** (👉) button is held down for longer than 3 seconds before the **Patient** (👤) button is pressed, the Menu mode will activate; if the **Select** (👉) button is pressed and released before the **Patient** (👤) button can be pressed, the Save menu is displayed.

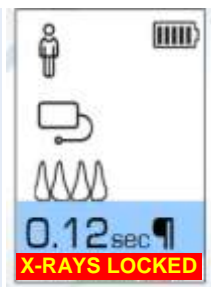

4.4 Ensuring the Right Exposure Time Is Set



Patient



Receptor



Tooth



Increase



Decrease

When power is turned off, the most recent setting for the exposure time is stored in memory and redisplayed when power is turned back on. However, if the battery is replaced, the display is reset to the default value.

To change exposure settings press each of the button options to toggle through the choices:

- 1) the **Patient Size** (adult or child),
- 2) the **Image Receptor** (film, phosphor plate, or sensor), and
- 3) the **Tooth Group** (Anterior, Posterior, or Bitewing).

Examples from factory default settings:

Child, Sensor, and Incisor = 0.09sec OR Adult, Film, and Molar = 0.38sec

When necessary, use the **Increase** or **Decrease** buttons to adjust the time in 0.01 second increments. Adjusted exposure settings may be saved, replacing factory settings (see Section 4.10, *Technique Factor Settings and Adjustments*).

0.09 sec

0.38 sec

Examples

4.5 Ready the Device

To prevent accidental radiation exposure, properly position patient and operator before readying the NOMAD Pro.

Press and release the trigger once to ready the device. The device will briefly display an **ENABLING X-RAYS** message before indicating **READY**.

NOTE: As a safety precaution, if the trigger is held longer than 1 second or pulled a second time while still in the **ENABLING X-RAYS** state, the device will not transition to the **READY** state. (This is to prevent an accidental activation of the device by unintended triggering.)

The illuminated green LED, the message **READY** on the display panel, and a double tone alert confirm that NOMAD Pro is prepared to fire X-rays. The **READY** state continues until either an exposure is initiated or timeout occurs after 15 seconds of inactivity (accompanied by a double tone alert and the return to the Settings mode).

While the device is in the **READY** state, any changes to the settings (pressing any user interface panel button) will end the state.



green

ENABLING X-RAYS



READY

0.20 sec

60 kV 2.5 mA

NOMAD Pro

4.6 Initiating and Completing an X-ray Exposure



yellow

To begin the exposure, press and hold the trigger. The **READY** message is replaced with **X-RAY ON**, the green LED is replaced with a yellow LED, and there is an alert tone 🔔 for the duration of the exposure.

To ensure complete exposure, keep the trigger depressed until the audible tone 🔔 is complete, the yellow LED is off, and **X-RAY COMPLETE** briefly displays.

NOTE: An exposure can be prematurely terminated for any reason by abruptly releasing the depressed trigger.

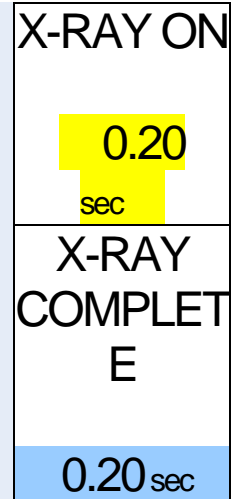

4.7 Power Off



Press and release the **Power** button to turn NOMAD Pro off.

NOMAD Pro also automatically shuts off after approximately 3 minutes of inactivity.

The NOMAD Pro display darkens, accompanied by a tone 🔔 to indicate shutdown.

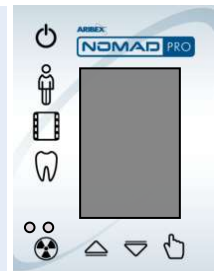

NOMAD Pro should not be operated if it has been dropped or performance degrades; it should be returned to Aribex for a safety check.

4.8 Exposure Techniques

As an intraoral dental X-ray system, the NOMAD Pro can be easily positioned. This high degree of flexibility easily makes possible exposures while the patient is reclined, lying completely on their back, or sitting upright. Ensure the patient is protected by using a radiation shielding drape.

- 1 When taking images, operators may hold the NOMAD Pro by having both hands on the handset grip, or for increased stability and patient safety by placing one on the grip and the other on the underside of the housing (but not on the collimator cone).
- 2 Position the NOMAD Pro relative to the imaging system to minimize cone-cutting. (If your practice uses film holding kits or aiming devices, check compatibility in advance.)
- 3 Exposure times increase proportionally when the imaging angles vary away from 90° (or perpendicular) to the film or sensor. To maintain low patient X-ray doses and keep the operator within the protection zone, have the head of the patient slightly tilted, and/or raise or lower the chin as needed. (See Section 2.1, *Radiation Safety*.)
- 4 When the device must be angled and the operator cannot be completely within the protection zone, ensure operator protection through the use of proper safety measures, such as the use of a lead apron. (See Section 2.1, *Radiation Safety*.)
- 5 Avoid touching the patient with the cone or backscatter shield; disposable plastic coverings can be used to prevent cross-contamination.
- 6 Determine what NOMAD Pro exposure time settings deliver optimal results for the type of imaging (digital or film-based) that is used on a regular basis.

NOTE: Both digital imaging sensors and film speeds can vary somewhat in their characteristics and could require different exposure settings to meet density preference. (See Section 4.9, *Settings Menu* for more information.)



NOMAD Pro

4.9 Settings Menu

NOMAD Pro menus allow the operator to customize settings according to individual preferences. To access the **Main Menu**, press and hold down the **Select** (⏏) button for 3 seconds. When the **Main Menu** appears, the operator can access the desired Menu item(s) by pressing the **Increase** (▲) and **Decrease** (▼) buttons to scroll up or down. When the desired Menu item is highlighted, press the **Select** (⏏) button to access the Menu item.

Within the Menu items there are options (such as **YES** and **NO** which are selected using either the **Increase** (▲) or **Decrease** (▼) buttons. Once a selection is made, pressing the **Select** (⏏) button confirms the choice.

To exit the **Main Menu**, highlight **EXIT** at the bottom of the list and then press the **Select** (⏏) button, or power the device off and then on.

Menu Item	Options
SYSTEM INFO	When system information is selected from the settings menu the device software version information will be displayed on-screen. Pressing the Select (⏏) button will return the operator to the Settings menu.
AUDIBLE SOUND	The volume may also be adjusted by the operator. The range is from 1 (softest), up to 5 (loudest). The Increase (▲) or Decrease (▼) buttons are used to adjust the volume, and the system emits a tone as each volume is selected so the operator can determine the choice. Once the desired volume is determined, pressing the Select (⏏) button saves the volume setting.
RESET DEFAULTS [Technique Factors and Trip Counter]	The operator can use the Increase (▲) or Decrease (▼) buttons to toggle between YES and NO in response to the menu prompt RESET EXPOSURE TIME TO FACTORY SETTINGS? If YES is selected, the system will confirm the selection by displaying ALL CUSTOM SETTINGS WILL BE ERASED. ARE YOU SURE? Selecting YES and then the Select (⏏) button reverts any any customized exposure settings to the factory defaults and returns the device to the Main Menu . If ever NO is selected and then the Select (⏏) button pressed, the customized settings will not be changed and the system returns to the Main Menu .











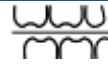

Menu Item	Options
X-RAY COUNTER	<p>The device will display two counters. One is the OVERALL HISTORY COUNTER which displays the total lifetime X-ray shots for the device. The other, TRIP COUNTER, can at any time be reset to 0 by the operator.</p> <p>When Reset is selected and the Select (↵) button is pressed, the user will be prompted with the message RESET TRIP COUNTER?</p> <p>When YES is selected and the Select (↵) button is pressed, the TRIP COUNTER is reset to 0 and the device is returned to the counters display.</p> <p>When NO is selected and the Select (↵) button is pressed, and the device is returned to the counters display with no change</p> <p>When BACK is selected and the Select (↵) button is pressed the device returns to the Main Menu.</p> <p>NOTE: RESET DEFAULTS also resets the TRIP COUNTER to 0.</p>
EXIT	Allows the user to leave the Main Menu and return to normal operation. (Powering off and then on also exits the menu.)

4.10 Technique Factor Settings and Adjustments



The factory settings in this chart are intended as a reference starting point only, and are based upon average preferences and use with the cone perpendicular to the image receptor. Individual results may vary based upon a number of factors including image density preferences, the various imaging sensors or available film speeds and brands, patient size, practitioner techniques and preferences.



Preset Technique Factors Chart

2.5 mA 60 kV

						
				Anterior	Posterior	Bitewings
	Digital Sensor	 	Adult	0.12	0.16	0.17
			Child	0.09	0.13	0.14
	Film	 	Adult	0.30	0.38	0.40
			Child	0.18	0.30	0.32
	Phosphor Plate	 	Adult	0.16	0.19	0.20
			Child	0.09	0.15	0.16

Technique Factor time setting can be adjusted by the operator. This is done from the main display screen following these steps:

- 1 Press the **Increase** () or **Decrease** () button until the desired time setting is selected.

NOTE: When the **Increase** () or **Decrease** () buttons are pressed AND held, the rate at which the displayed time setting changes on screen suddenly accelerates.

- 2 Press and release the **Select** () button to activate the Save menu.

- 3 Select **YES** by pressing the **Increase** button ()

- 4 Press the **Select** () button to select **OK**.

- 5 Once saved, this change will be maintained in memory until overwritten or until the factory defaults are restored through the **RESET DEFAULTS** Menu item.

5.0 Handset Replacement and Care

A **RECHARGE HANDSET** alarm on the display panel indicates either the need to fully engage the handset or the need for a replacement handset. NOMAD Pro cannot emit X-rays with a low, depleted battery (insufficient voltage). Follow these steps to clear the **RECHARGE HANDSET** alarm.

- 1 Verify that the handset is locked in place. If so and the alarm is still present, press and release the **Power** (⏻) button on the control panel to turn off NOMAD Pro
- 2 Place the NOMAD Pro bottom up on a stable surface and depress the release button on the housing, just behind the handset, to release it from the housing.
- 3 Slide the Handset forward toward the backscatter shield and the collimator cone.
- 4 Carefully align a newly charged handset and, while avoiding possible pinch points between the housing and the handset, slide it into place – a properly oriented handset should snap into place without force. A clicking sound ensures that the handset is fastened. Make sure the handset is secure by pushing it toward the cone. When a handset is detached for more than 60 seconds, the last exposure setting is erased (and would have to be reset when the unit is turned on again).



IMPORTANT HANDSET CARE NOTES:

- Each handset can go through the full discharge/charge cycle approximately 300 times. Routinely change discharged handset with fully charged one as needed.
- The handset can be left indefinitely on the charging cradle without damaging batteries, unless AC power to charging cradle is completely interrupted or turned off during the charge cycle.
- Battery charge will diminish during extended inactivity – **fully recharge handsets every 3 months during inactivity**. Never place a low charge battery into long-term storage.
- When the charging cradle senses a bad handset battery, the indicator lights will illuminate red rather than green. In this case, the batteries are inoperable and must be serviced.
- Handset communications and mechanical integrity are checked by pulling the handset trigger when it is on the charging cradle – good communication exists when the indicator lights illuminate orange.





- **Do not attempt to charge a handset with damaged batteries.**
- **Risk of fire or explosion exists if batteries inside the handset are replaced by unauthorized service personnel; do not use batteries from other sources.**
- **Properly dispose of spent or damaged handset; return to Aribex or an authorized distributor for replacement and recycling. Do not place in municipal waste stream.**







6.0 NOMAD Pro Care and Upkeep

6.1 Alarms and Alerts

The visual/audible alarm signals a programmed action designed to prevent harm to operator, patients, and/or NOMAD Pro. The visual/audible alerts confirm normal conditions or draw the operator’s attention to a required action.

NOTE: All audible signals except X-ray termination may be turned down or off in the **AUDIBLE SOUNDS** menu – see Section 4.9, *Settings Menu*.

Condition	Visual Indicator	Audible Signal 	Function / Resolution
Enabling Alert	ENABLING X-RAYS	None	This state is initiated by a single pull and release of the trigger, within 1 second. If no further action is taken, the device will shift into the READY state. If the trigger is pulled again before the READY state is indicated, the 1 second counter will restart.
Ready for exposure Alert	READY  0.20sec.....	Double ascending tone	At the conclusion of the ENABLING X-RAYS message, the READY message will display on-screen. The READY state will last for 15 seconds, or until one of the buttons on the user interface panel is pressed, or until the exposure is initiated by a second pull of the trigger.
X-ray Exposure Alert	X-RAYS ON  0.20sec	Single tone, for duration of exposure	At the end of the successful exposure the yellow LED turns off, and display panel briefly indicates X-RAY COMPLETE and the screen returns to the normal mode.

Condition	Visual Indicator	Audible Signal 	Function / Resolution
<p>X-ray Lock</p> <p>Alert</p>		<p>Tones will be the same as the actual operation tones</p>	<p>When the trigger is activated while the device is in the X-rays locked mode and operation is attempted, various alert messages will be displayed. For example: X-RAYS LOCKED, SIMULATION ONLY, SIMULATION COMPLETE.</p> <p>Toggle between LOCKED and UNLOCKED by pressing and holding down hold down the Select () button and then press the Patient () button.</p>
<p>Duty Cycle Exceeded</p> <p>Alarm</p>	<p>COOLING DOWN</p> <p>[count down]</p>	<p>Double tone at the start and end of the cool down cycle</p>	<p>If the operator presses the trigger to activate the READY state before the duty cycle time, the device will display the warning message, and a countdown timer will be displayed showing the duty cycle time remaining. This will lock the device and the message will be displayed until the duty cycle is complete. The device will then return to the normal operation mode.</p>
<p>Low Battery</p> <p>Alarm</p>	 <p>RECHARGE HANDSET</p>	<p>5 audible tones</p>	<p>Ensure the Handset is locked in place.</p> <p>The RECHARGE HANDSET alert terminates after five seconds and goes into auto-shutdown. Replace the current Handset with a freshly charged Handset.</p> <p>NOTE: If battery voltage is lower than required for the X-ray exposure, the device will not allow the exposure.</p>
<p>Incomplete Exposure</p> <p>Alarm</p>	<p>INCOMPLETE</p> <p>(PRESS ANY KEY)</p> 	<p>A warning tone</p>	<p>Activates if trigger is released before the timed X-ray exposure finishes.</p> <p>This condition is cleared by pressing any button on the user interface panel or by tuning the power off then on.</p> <p>Depress the trigger for the duration of the exposure time.</p>

NOMAD Pro

Condition	Visual Indicator	Audible Signal ◀	Function / Resolution
System Failure Alarm	SYSTEM FAILURE CALL MANUFACTURER	Descending tone	Consult Section 6.2, <i>Troubleshooting</i> (6.2.8) or an Aribex authorized service center.
Handset Failure Alarm	HANDSET FAILURE	5 audible tones	Consult Section 6.2, <i>Troubleshooting</i> (6.2.12) or an Aribex authorized service center.



NOMAD Pro should not be operated if it has been dropped or performance degrades; it should be returned to Aribex for a safety check.

6.2 Troubleshooting

If you encounter results and/or errors in the operation of NOMAD Pro that are not explained in the previous sections, check the following table on user troubleshooting to determine the need for authorized service. If you have additional questions or require help contact Aribex: support@aribex.com

Device Symptom	Potential Problem	Corrective Action
6.2.1 Image from X-ray exposure did not have sufficient contrast	Underexposure (too light).	Increase the exposure time setting; or see Incomplete Exposure below.
	Overexposure (too dark).	Decrease the exposure time setting, also check film expiration date (old film can produce dark grainy/foggy images).
	Chemical developer (for film-based imaging).	Ensure chemical freshness and proper temperature.
6.2.2 Image from X-ray exposure is blurred	Combined movements of patient and operator during exposure produced too much distortion.	Check the exposure time setting and re-enable when operator and patient are again properly situated.
6.2.3 ENABLING X-RAYS message stays on	Double triggering.	Release the trigger and wait for the READY indicator.
6.2.4 Device does not shift into the ENABLING X-RAYS or READY states	The trigger is pulled for longer than 1 second.	Pull and release the trigger within 1 second and wait for the READY indicator.
6.2.5 READY indicator terminated before an exposure started	NOMAD Pro READY condition expires because the X-ray exposure is not initiated within 15 seconds of the start of the READY condition.	Double-check the exposure time setting and re-enable when operator and patient are again properly situated.
6.2.6 INCOMPLETE displayed on-screen	Incomplete exposure – the depressed trigger is released before the timed exposure is able to complete.	This condition automatically clears within 15 seconds or by pressing any button on the user interface panel. Be sure to depress the trigger for the duration of the timed exposure.
6.2.7 NOMAD Pro automatically shut down	NOMAD Pro times out after about 3 minutes of inactivity.	Manually turn on NOMAD Pro when you are ready to use the device.
	A different problem exists if shutdown occurred during regular activity.	If this condition persists, NOMAD Pro will require authorized service, see Section 6.3, <i>Repair and Maintenance</i> .

NOMAD Pro

Device Symptom	Potential Problem	Corrective Action
6.2.8 SYSTEM FAILURE displayed on-screen	Self diagnostics, which automatically run at startup and while the device is on, detects a potential issue.	This warning message can be cleared by powering off, then on. If device self-diagnostics detects the system failure again after clearance, the message will redisplay and NOMAD Pro will require authorized service; see Section 6.3, <i>Repair and Maintenance</i> .
6.2.9 There was no power to the NOMAD Pro control panel	If pressing Power several times does not cause the display to illuminate, the attached handset is the likely problem.	Ensure handset is securely attached. Replace with a newly charged handset in order to continue. Use the charging cradle to determine if the first handset battery can be recharged or is spent and must be taken out of service.
	A different problem exists if all handsets appear fully charged.	NOMAD Pro will require authorized service; see Section 6.3, <i>Repair and Maintenance</i> .
6.2.10 When first placing handset on charging cradle, indicator lights illuminated orange	Male connectors on charging cradle are damaged (can also happen to NOMAD Pro device connectors).	NOMAD Pro will require authorized service; see Section 6.3, <i>Repair and Maintenance</i> .
6.2.11 The handset did not seem to be working when the trigger was pulled	The trigger is not communicating with the device.	Ensure handset is securely attached.
		Place handset on the charging cradle and pull the trigger. If the indicator lights illuminate orange, the handset trigger communications are functional. NOMAD Pro may require authorized service; see Section 6.3, <i>Repair and Maintenance</i> .
6.2.12 HANDSET FAILURE displayed on-screen	The handset, in general, is not communicating with the device.	Ensure handset is securely attached.
	The protective fuse in the handset is blown, the batteries are otherwise impaired or at the end of their life cycle.	Replace with a newly charged handset in order to continue. Use the charging cradle to determine the handset status. If the indicator lights illuminate solid or flash red, the handset will require authorized service; see Section 6.3, <i>Repair and Maintenance</i> .

6.3 Repair and Maintenance

NOMAD Pro is a maintenance-free product. However, a routine wipe-down with a disinfectant cloth or wipe is recommended between patients, along with a quarterly visual inspection for damage. Make sure the power is off while cleaning. It is recommended for the handset to be attached during cleaning of the device, so that the electrical contacts are not exposed. Use a **non-acetone** based disinfectant wipe or a cloth to wipe the exterior surfaces of the NOMAD Pro and charging cradle.

See also Section 5.0, *Handset Replacement and Care* for more information related to battery maintenance.



The NOMAD Pro, the handsets, and the charging cradle are NOT designed to be user-serviceable. There are dangerous voltages inside. Do not open the device housing; doing so will void the warranty.

Repairs can only be undertaken by trained service personnel. Direct all questions to an authorized distributor.

The following are user replaceable components:

- Optional Rectangular Collimator Cone Adapter (AP-0036)
- Handsets (AP-0025)
- Charging Cradle (AP-0035)
- AC to DC Power Supply (CP-0062)
- Optional Hard-Shell Carrying Case, plastic (AC-0004)

Damaged or faulty NOMAD Pro materials and components must be properly disposed of according to local requirements, or returned to an authorized distributor or Aribex, Inc. Please protect the environment, and do not improperly dispose of any part of the NOMAD Pro system, the handsets, the charging cradle, or the AC power supply. At end of life, return these items to Aribex for replacement, and proper disposal or recycling.

If product return is required, contact Aribex for a Return Material Authorization (RMA) number and shipping instructions to return the product to the proper facility. If the product is under warranty, you will be required to provide the serial number from the label affixed on the underside of the NOMAD Pro.

Be sure to include the RMA number on the package you are returning. Products without an RMA number cannot be processed.

Aribex will not assume responsibility for shipping damages; however, we will help you file a claim with the freight carrier. Please see warranty information at the end of this manual.

7.0 Technical Description

7.1 Basic Technical Specifications

Maximum deviation from fixed factors	±5% (unless otherwise noted)
Total weight	2.5kg (5.5 lbs)

Environmental

Operation	
Temperature	−5 to +40°C (+23 to +104°F)
Relative humidity	10% to 80%, non-condensing
Storage and transportation	
Temperature	−20 to +60°C (−4 to +140°F)
Relative humidity	95%, non-condensing

Classification / Spec Compliance

IEC 60601-1 (Amend 1 & 2), 60601-1-3, 60601-2-7; 21 CFR 1020.30 & 1020.31	Internally Powered	
MDD (93/42/EEC): Annex IX	Type BF	
IPX specification	Class IIb	
Mode of operation	IPX0; do not operate under wet conditions	
Conductive connection to patient	Intermittent operation	
For use in environments where no flammable anesthetics and/or flammable cleaning agents are present; non-acetone based disinfectant wipes or cloths.	No conductivity with the applied part	

Electrical

Rechargeable lithium batteries	22.2V nominal; 25.2V maximum, 1.25A/hr
Low battery alert set point	Any cell (of the 6) <3.5V
Battery current at 2.5mA, 60kVp output	12.5A
Maximum energy input in one hour	150W

X-ray Controls and Generator

Exposure time range	0.02–1.00 sec. (in 0.01 second increments)
Minimum duty cycle	1:60 (one 1 second exposure every 60 seconds)
Minimum permanent filtration	≥1.5mm Al (0.8mm glass, 0.5mm Al, 0.2mm plastic cap)
Maximum output power	150W nominal at 60kV, 2.5mA
Generator rating	2.5mA (±5%) at 60kVp (±10%)
Leakage technique factors	60kV, 2.5mA, 1.00 sec.
Maximum air kerma at handgrips and control panel	<0.05mGy in 1 hour

Measurement Base of Technique Factors

The kV is measured during pre-pot testing using a calibrated high voltage divider with a guaranteed accuracy of $\pm 2\%$. Final performance measurements are made using a NERO mAx, model 8000 X-ray meter from Victoreen. Tube current is sensed across a series connected resistor with an accuracy of $\pm 1\%$ and measured using a digital multimeter, prior to encapsulation; NOMAD Pro has no provision for external measurement of beam current after final manufacture. Exposure time is measured during the entire exposure, referenced to 75% rise/fall, using the NERO mAx 8000 x-ray meter.

Collimator Cone

Minimum <i>source to skin</i> distance	20cm (from focal spot to cone tip)
Nominal dose output at cone tip (20cm)	3.41mGy / sec.
X-ray field size and configuration	6cm diameter circle

7.2 Wiring Diagram

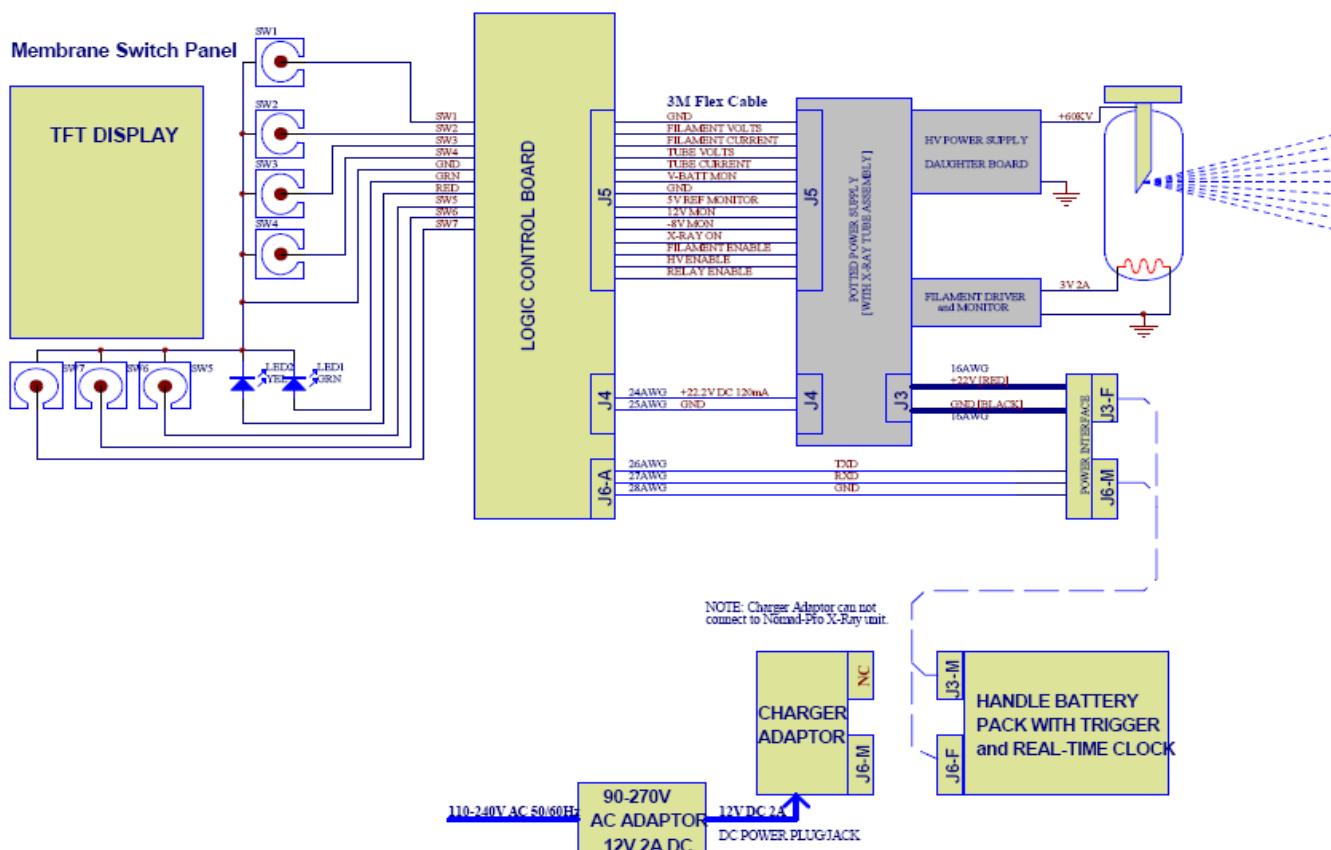

7.3 X-ray Tube Specifications and Characteristics

The VDT70/0.4/12CP is designed for intraoral dental imaging by an X-ray unit, and is available for nominal tube voltage with self-rectified or constant potential circuit – manufactured by Kailong; distributed in the U.S.A. by Vista Technology.

Nominal tube voltage	60kV
Nominal focal spot (IEC 60336:1993)	0.4mm
Maximum anode heat content	4500J
Maximum current continuous service	1.5mA x 70kV
Maximum anode cooling rate	100W
Nominal anode input power	430W
Target material	Tungsten
Target angle	12°
Filament characteristics	2.2–3.0A, 2.0–3.5V
Minimum inherent filtration (IEC 60522:1999)	0.8mm Al / 50kV

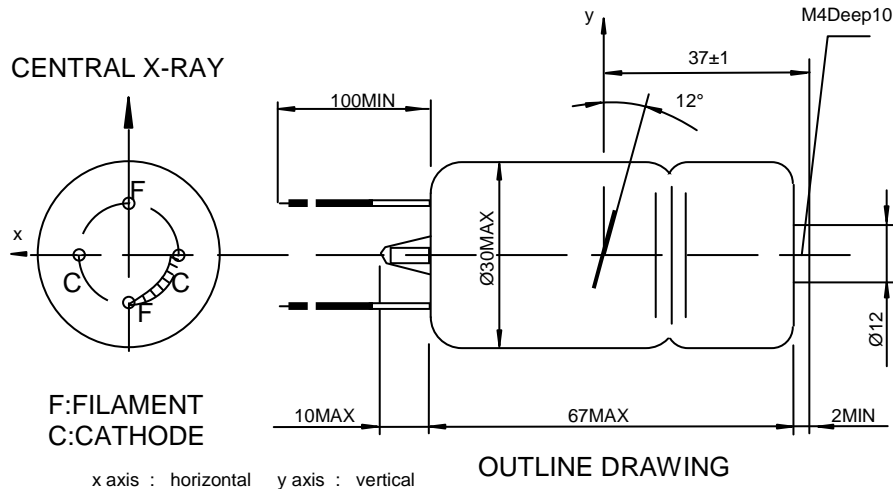

X-ray source assembly maximum heat content	6500J
X-ray source assembly (mfg by VMI)	PS454

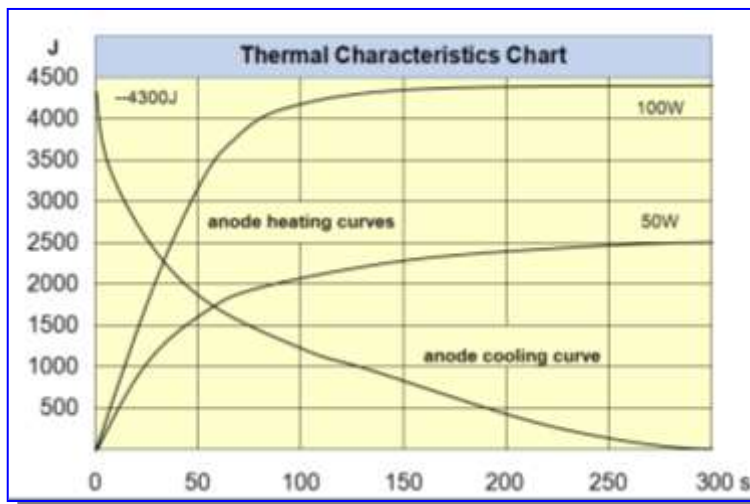
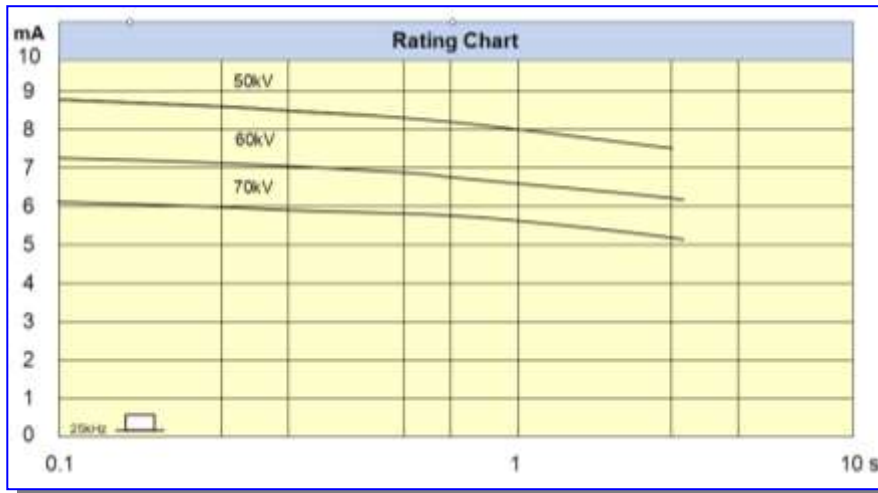
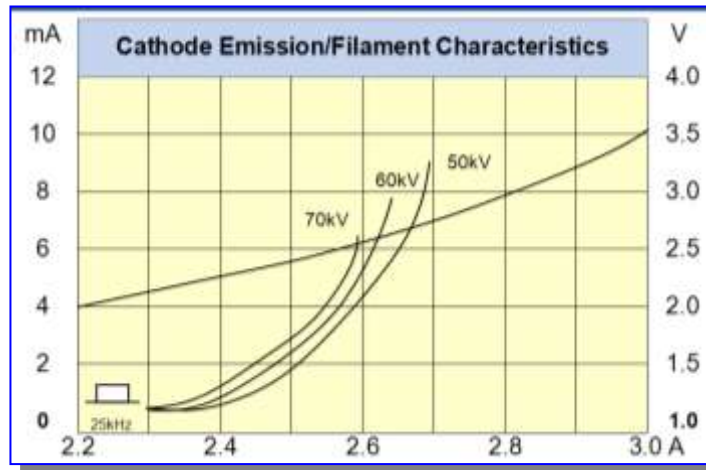

NOTE: The X-ray source assembly heating and cooling curves are equivalent to the anode heating curves shown here.

Maximum continuous heat dissipation will be made available upon request from Aribex.

NOMAD Pro

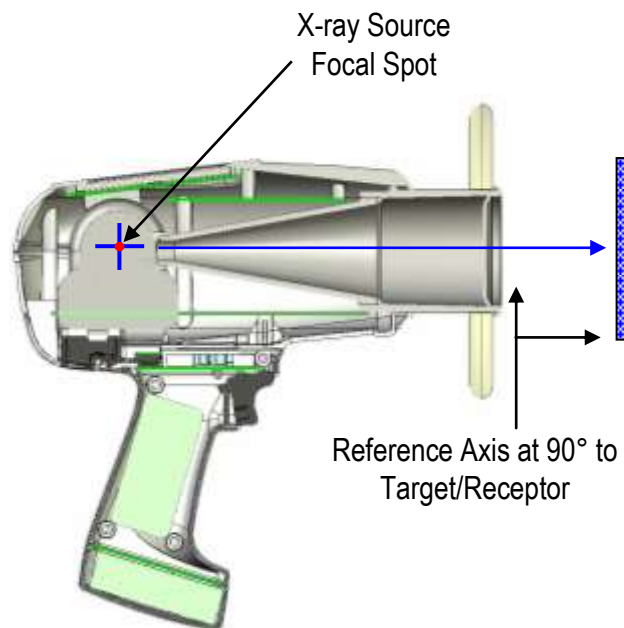
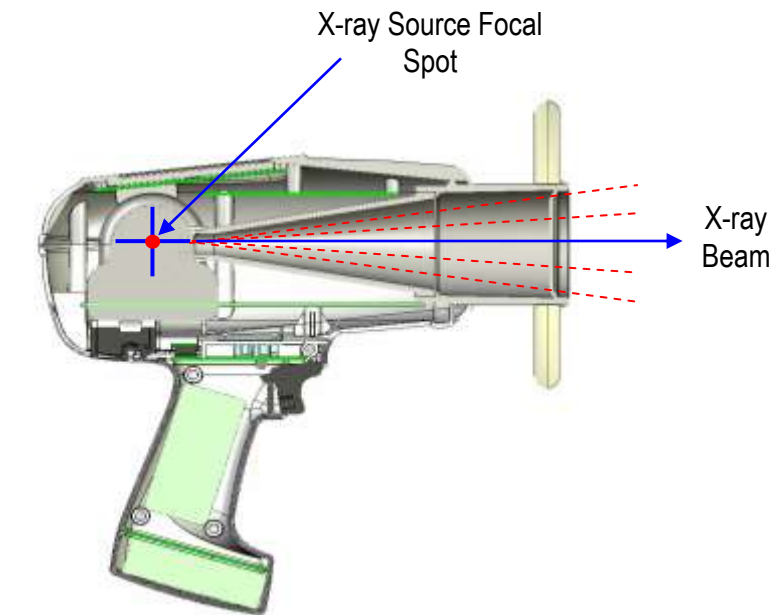

7.4 EMC Data

Independent laboratory testing for electromagnetic compatibility for conformity to the Sub-clause 5.10 requirements of ISO/IEC 17025 "General Criteria for the Competence of Testing and Calibration Laboratories" was conducted by:

Nemko USA, Inc.
11696 Sorrento Valley Rd, Suite F
San Diego, CA 92121-1024
USA

The NOMAD Pro Dental X-ray System has been tested and found to comply with the limits of electromagnetic compatibility standards for medical devices, which provide reasonable protection against harmful interference in a typical medical/dental setting. The NOMAD Pro may generate and radiate radio frequency energy that causes interference to other devices in the vicinity, if not used in accordance with the instructions (though there is no guarantee that interference will not occur in a particular instance). If interference occurs, the user is encouraged to try the following corrective measures: reorient or relocate the receiving device; increase the separation between the equipment; consult the device manufacturer or field service technician for help.

NOMAD Pro is intended for use in the electromagnetic environment as specified. The following tables describe the tests performed and the status of the testing. The NOMAD Pro uses RF energy only for its internal function. In addition, the housing includes conductive shielding; therefore, its RF emissions are very low and are not likely to cause any interference in nearby electronic equipment.

The test results show that the NOMAD Pro is suitable for use in all establishments, including domestic establishments and those directly connected to public low-voltage power supply network that supplies buildings used for domestic purposes.

Test Specifications: Radio Frequency Emissions and Electromagnetic Immunity tests in accordance with requirements of EN 60601-1-2:2001, A1:2006 (as follows).

Test Type	In Accordance with Document	Document Title
Conducted and Radiated Emissions	EN 55011:2007, Class "B"	Industrial, Scientific and Medical (ISM) Radiofrequency Equipment – Radio Disturbance Characteristics – Limits and Methods of Measurement
Electrostatic Discharge Immunity	IEC 61000-4-2:1995, A1:1998, A2:2000	Electromagnetic Compatibility, Basic Immunity Standard, Electrostatic Discharge Immunity Test
Radio Frequency Immunity	IEC 61000-4-3:2006	Electromagnetic Compatibility, Basic Immunity Standard, Radiated Radio Frequency Electromagnetic Field, Immunity Test
Power Frequency Magnetic Field Immunity	IEC 61000-4-8:1993, A1:2000	Electromagnetic Compatibility, Testing and Measurement Techniques for Power Frequency Magnetic Field, Immunity Test

NOMAD Pro

NOTE: The tests documented in the table above are the only tests required for this product as it is a battery operated device and the AC Adapter (CP-0062) is certified. IEC 61000-3-2, 3-3, 4-4, 4-5, 4-6, 4-11, and EN 55014-1:2006 are not applicable.

Emissions Test Summary

Specification	Frequency Range	Compliance Status
EN 55011:2007, Group 1, Class "B" Conducted Emissions	0.15MHz – 30.00MHz	PASS
EN 55011:2007, Group 1, Class "B" Radiated Emissions	30.0MHz – 2500MHz	PASS
EN 61000-3-2:2000, A2:2005 Power Line Harmonics	Up to the 40th Harmonic	N/A, for a battery powered device
EN 61000-3-3:1995, A1:2001, A2:2005 Power Line Flicker	Less than or equal to 4% Maximum Relative Voltage Change; Value of D(T) ≤3% for more than 200ms	N/A, for a battery powered device
EN 55014-1:2006 Discontinuous Disturbance ("Click")	0.15MHz – 30.00MHz	N/A, for a battery powered device

Immunity Test Summary

Specification	Minimum Test Level Required per EN 60601-1-2	Test Level Completed	Compliance Status
IEC 61000-4-2:1995, A1:1998, A2:2000 – Electrostatic Discharge Immunity	Air discharge up to ±8kV; contact discharge up to ±6kV	Air discharge up to ±8kV; contact discharge up to ±6kV	PASS
IEC 61000-4-3:2006 – RF Radiated Fields Immunity	Radiation field strength of 3V/m from 80 – 6000MHz (80% AM @ 1kHz)	Radiation field strength of 3V/m from 80 – 6000MHz (80% AM @ 1kHz)	PASS
IEC 61000-4-4:2004, Corrigendum 1:2006 – Electrical Fast Transient Immunity	Power line pulses of ±2kV direct; I/O line pulses of ±1kV	Power line pulses of ±2kV direct; I/O line pulses of ±1kV	N/A, for a battery powered device
IEC 61000-4-5:2005 – Lightning Surge Immunity	Power line surges of ±2kV common, ±1kV differential mode	Power line surges of ±2kV common, ±1kV differential mode	N/A, for a battery powered device
IEC 61000-4-6:2003, A1:2004, A2:2006 – RF Common Mode Immunity	150kHz – 80MHz at 3 Vrms, 1kHz 80% amplitude modulated	150kHz – 80MHz at 3 Vrms, 1kHz 80% amplitude modulated	N/A, for a battery powered device
IEC 61000-4-8:1993, A1:2000 – Power Frequency Magnetic Field Immunity	Helmholtz coil at 50Hz and 60Hz, to 3 amps (rms) per meter	Helmholtz coil at 50Hz and 60Hz, to 3 amps (rms) per meter	PASS
IEC 61000-4-11:2004 – Voltage Dips and Short Interruptions	Voltage Dips of >95%, 30% and 60%; Interruptions of >95%	Voltage Dips of >95%, 30% and 60%; Interruptions of >95%	N/A, for a battery powered device

7.5 Optional Calibration Checks

The NOMAD Pro is factory calibrated and tested prior to release (see your *Certificate of Conformance*) and there are no adjustment options. A self-diagnostics is completed each time the device is powered up. However, the **optional** checks listed below may be performed by a qualified technician as desired.

Setup a calibrated Performance Meter (such as the Victoreen NERO, mAx model 8000) according to manufacture's specifications to detect and report the following: X-ray Tube Voltage [kV Effective Mode], Radiation Time [ms Effective Mode], and Dose [mR Average Mode]. The filter card for the Test Detector should be in the 50-100kVp position.

Measurement Method: Final performance measurements are made using a NERO mAx, model 8000 X-ray meter from Victoreen. Tube current (mA) is sensed across a series connected resistor with an accuracy of $\pm 1\%$ and measured using a digital multimeter, prior to encapsulation; NOMAD Pro has no provision for external measurement of beam current after final manufacture. Exposure time is measured during the entire exposure; referenced to 75% rise/fall, using the NERO mAx 8000 X-ray meter. Accelerating voltage (kV) is measured at both peak (kVp) conditions and effective conditions (kVeff), which is the equivalent kV as if the kV were constant through the whole exposure time. Linearity is calculated per IEC 60601-2-7, 50.102.2a.



This X-ray unit may be dangerous to testing technician and any bystanders unless safe test exposure factors, such as placing the Test Detector in a lead lined box or the use of a protective lead apron are observed.

Enable the NOMAD Pro and, with the cone perpendicular to the Test Detector, make exposures into the Test Detector and capture the resulting data.

Compare the result with the factory release parameters (indicated in the chart below). For results outside these parameters, discontinue use and contact your dealer/distributor or Aribex.

Test Description	Acceptance Limits	Timer Settings and Corresponding Acceptable Ranges				
		0.02 sec	0.04 sec	0.40 sec	0.60 sec	1.00 sec
kVp (eff) Accuracy	60kV $\pm 10\%$	54 to 66	54 to 66	54 to 66	54 to 66	54 to 66
Timer Accuracy	Setpoint $\pm 10\%$, +1ms	17 to 23	35 to 45	359 to 441	539 to 661	899 to 1101



A duty cycle of 1:60 is required after each X-ray discharge to prevent over-heating damage to the X-ray tube.

LIMITED WARRANTY

COVERAGE. Aribex, Inc. warrants its medical and dental x-ray equipment to be free from any defects in material or workmanship for a period of one (1) year from the date of purchase. Aribex, Inc. also warrants any accessories purchased from Aribex to be free from any defects in material or workmanship for the period of one (1) year from the date of purchase.

The liability of Aribex, Inc. is limited to repair or replacement of any parts that Aribex or its authorized resellers determine to be defective. Contact Aribex for a Return Material Authorization (RMA) number and shipping instructions. Parts proving defective shall be repaired or replaced free of charge (labor and domestic shipping included), if defective equipment is returned freight collect to Aribex (Utah, USA) or the location of the authorized service center. Equipment repaired or replaced under warranty shall continue to be warranted for the balance of the original warranty term. All warranty claims must be made not later than ten (10) business days following the expiration of the applicable warranty period.

LIMITATIONS OF COVERAGE. This warranty does not apply to equipment that is or has been abused, misused, or altered (including opening enclosure or tampering), improperly maintained, subjected to use beyond rated conditions, or damaged as a result of any carelessness or accidents. This warranty does not cover ordinary wear and tear or maintenance.

LIMITATIONS OF LIABILITY. Aribex, Inc. makes no other warranty, either expressed or implied, with respect to any equipment purchased from Aribex, including without limitation any implied warranties of merchantability or fitness for a particular purpose, whether or not Aribex may have been informed of the actual uses to which any of such equipment may be put. Aribex, Inc. shall not under any circumstance be liable for incidental, indirect, consequential, punitive or exemplary damages, including without limitation damages for delay or lost profits, and in no event shall liability of Aribex arising from the purchase, sale or use of the equipment, or breach of any warranty made above, exceed in the aggregate the purchase price paid therefore.



0473

ISO 13485 / ISO 9001
CERTIFIED COMPANY

© **Aribex, Inc. 2005, 2010**
All Rights Reserved

English is the original draft language for this manual.

Aribex, Inc.
744 South 400 East
Orem, Utah 84097
U.S.A



Phone: 801-226-5522
Fax: 801-434-7233
Email: NOMAD@aribex.com
<http://www.aribex.com>

EC

REP

MT Promedt Consulting, Altenhofstr. 80, 66386 St. Ingbert, Germany

MP-0074, Rev E